

altın
büro ab

OFFICE CHAIRS AND COMPONENTS



www.altinburo.com.tr



HAKKIMIZDA

Firmamız 1993 yılında ofis koltukları aksamı imalatı üzerine kurulmuştur. Biz ofis koltukları ve aksamları imalatında vidasından tekerine profesyonel bir anlayışla imalat yapmaktayız. 24 yıllık çalışmamızda müşterilerimize en iyi kaliteyi ve servisi sunabilmek bizim için en iyi mutluluk olmuştur.

Zamanın hizmet, Kaliteli ürün ve Sürekli gelişen yaratıcılığı olan, Müşteri hizmetlerinde Onların görüşlerini " Güven ve Destek " içinde dikkate alan bir anlayışla imalatına devam etmektedir.



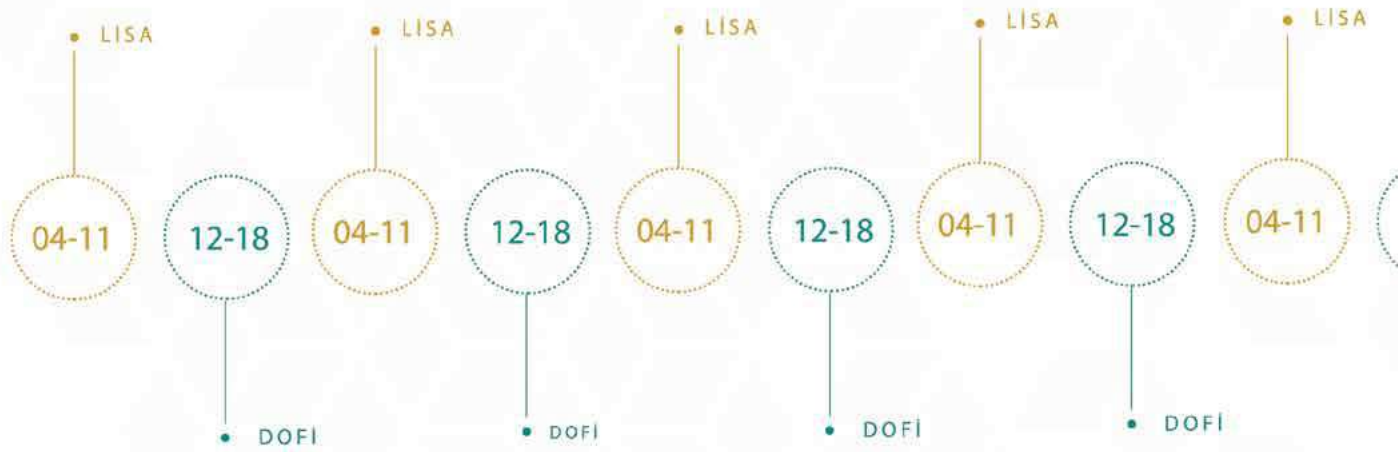
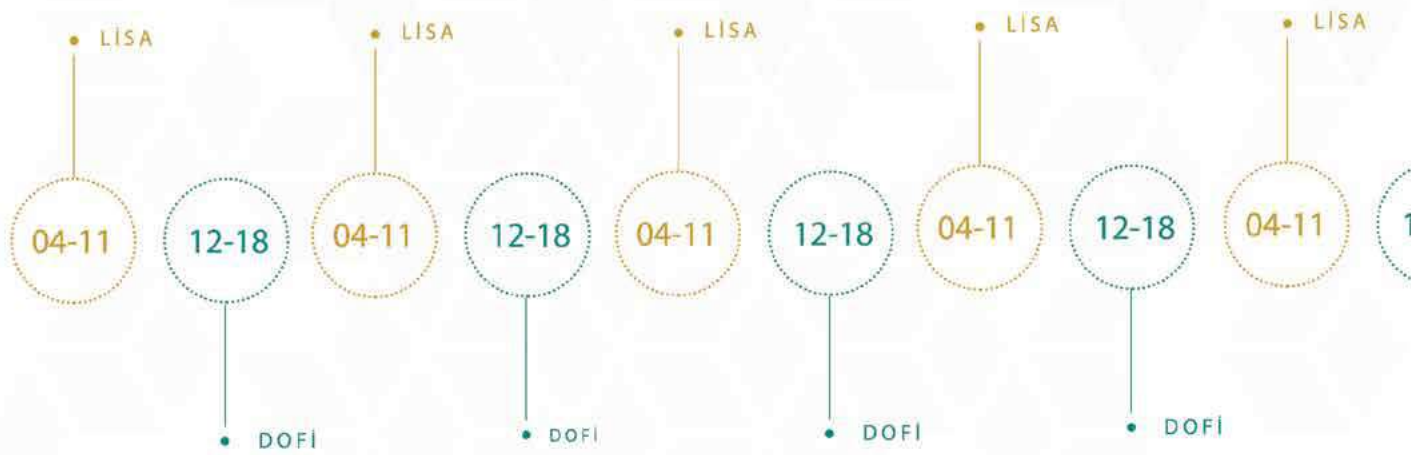

İÇİNDEKİLER

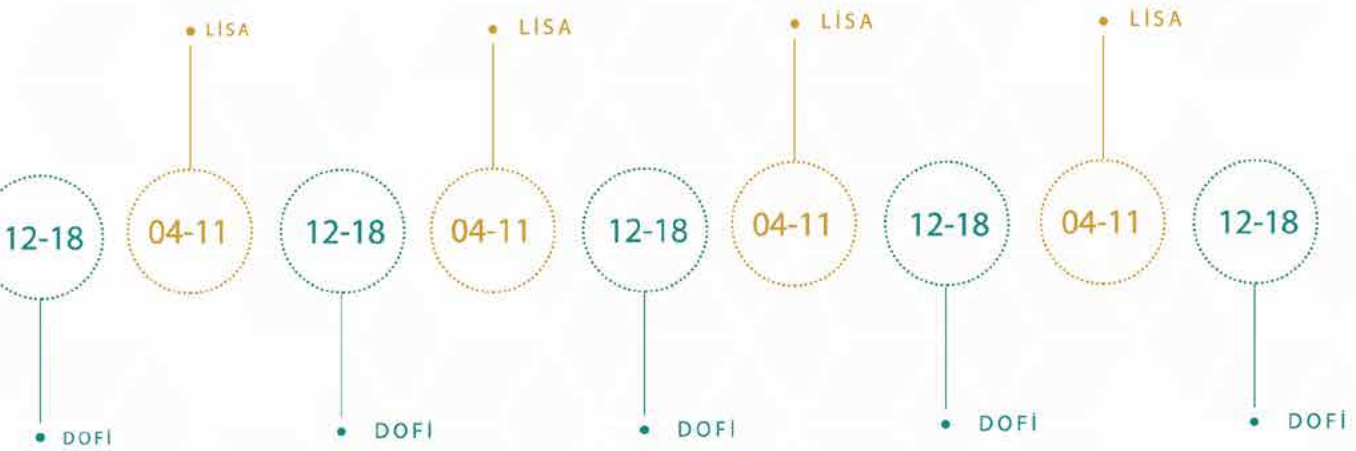
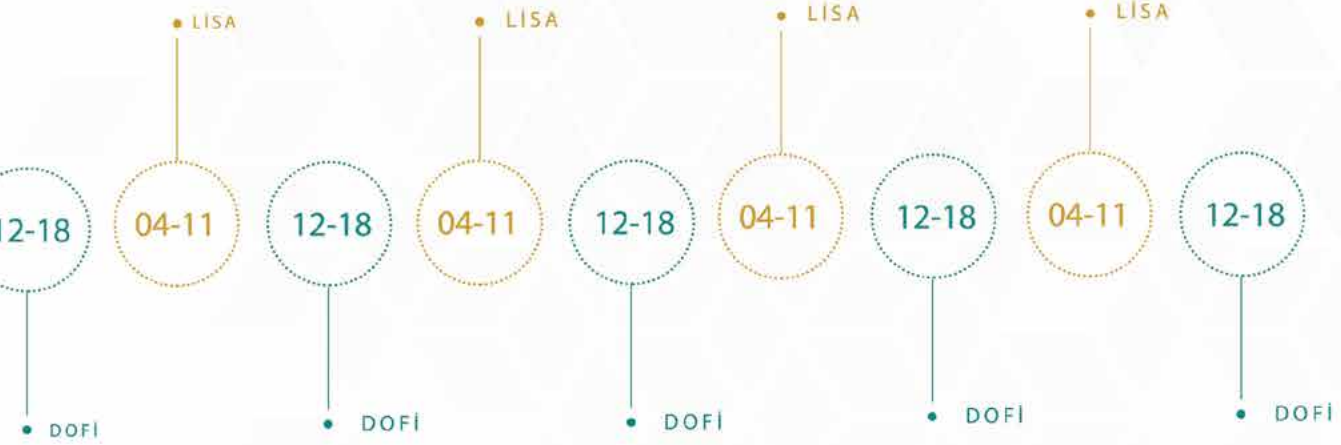

LİSA / AC8201 / COMPONENTS

LİSA

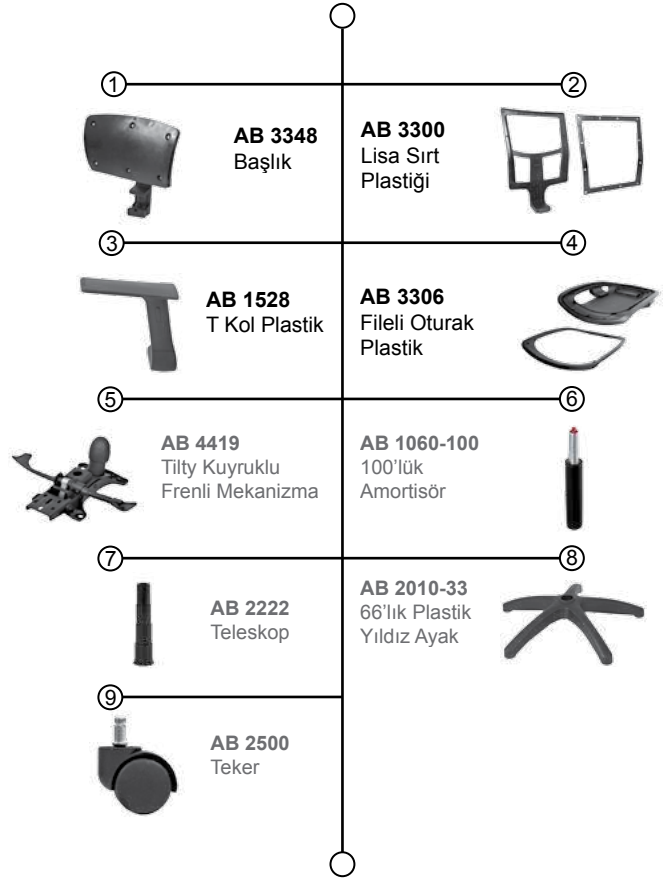

LİSA / AC8206 / COMPONENTS



LİSA / AC8216 / COMPONENTS



LİSA / AC8217 / COMPONENTS



LİSA



①	AB 3348 Başlık	AB 3300 Lisa Sırt Plastiği	②
③	AB 1634 Ayarlı Kol	AB 3355 Tetra Oturak İç ve Dış Plastiği	④
⑤	AB 4419 Tilty Kuyruklu Frenli Mekanizma	AB 1060-100 100'lük Amortisör	⑥
⑦	AB 2222 Teleskop	AB 2010-33 66'lık Plastik Yıldız Ayak	⑧
⑨	AB 2500 Teker	AB 7729 Tetra Oturak Sünger	⑩



①	AB 3300 Lisa Sırt Plastiği	AB 1634 Ayarlı T Kol	②
③	AB 3355 Tetra Oturak İç ve Dış Plastiği	AB 4419-2 Tilty Frenli Basit Kuyruklu	④
⑤	AB 1060-100 100'lük Amortisör	AB 2010-33 66'lık Plastik Yıldız Ayak	⑥
⑦	AB 2222 Teleskop	AB 7729 Tetra Oturak Sünger	⑧
⑨	AB 2500 Teker		⑩

LİSA / AC8224 / COMPONENTS



LİSA / AC8250 / COMPONENTS

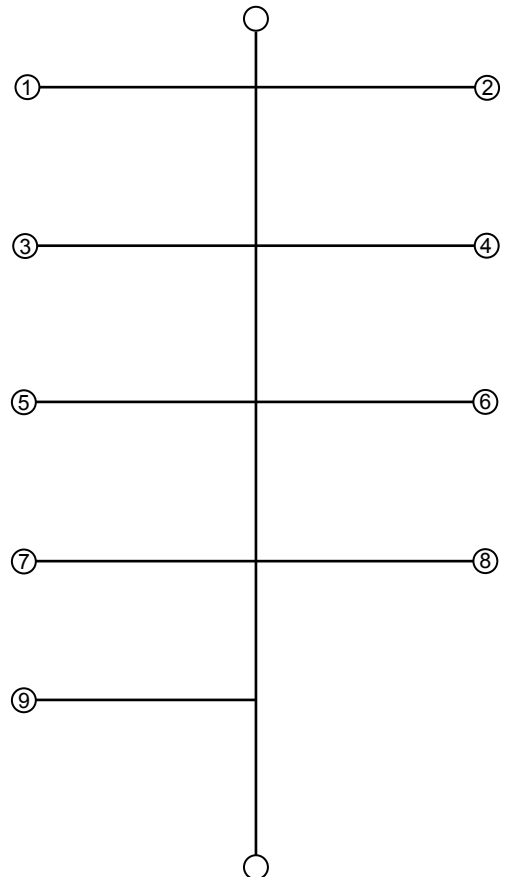

LISA

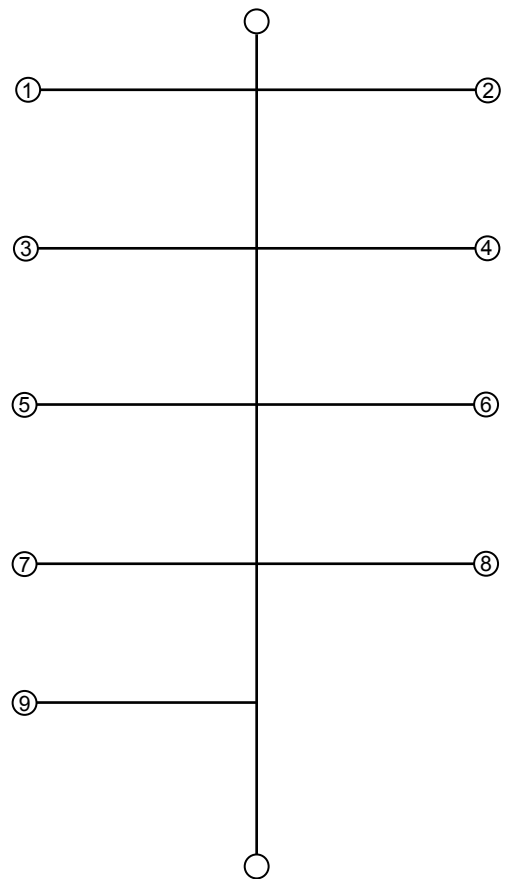
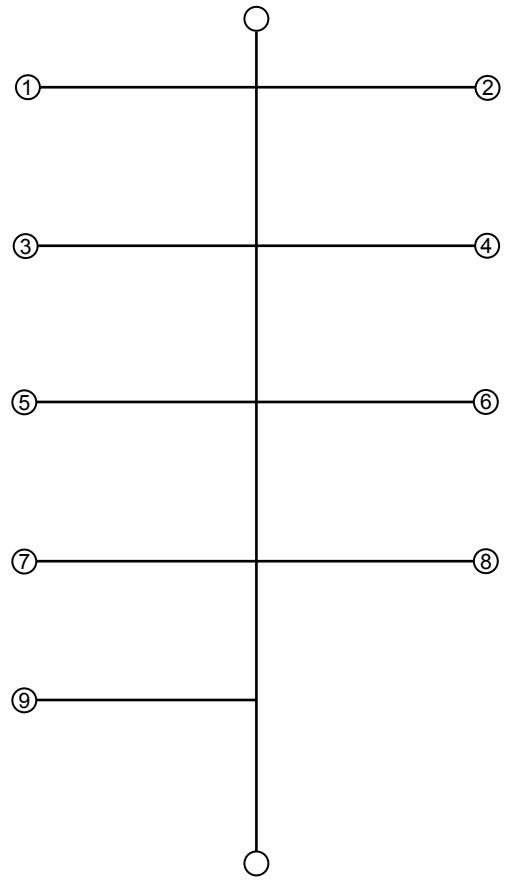

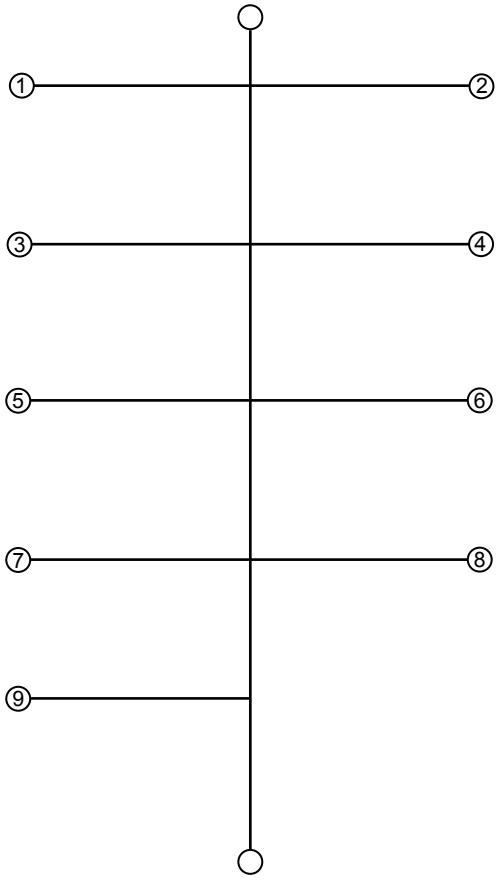

LİSA

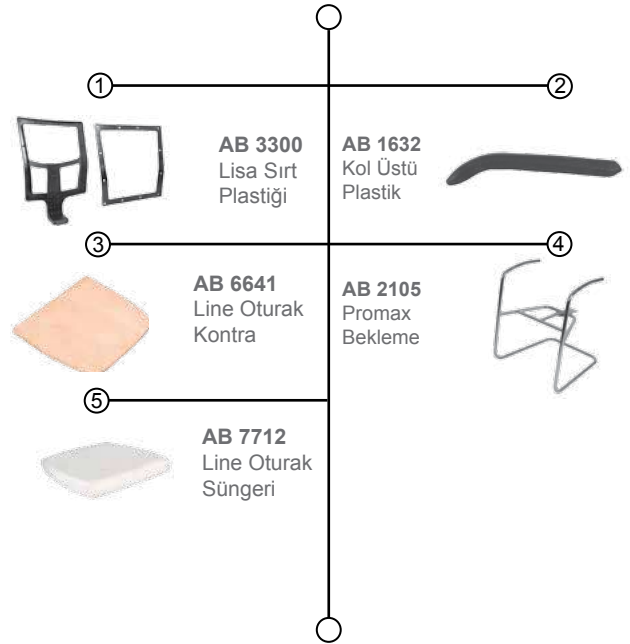
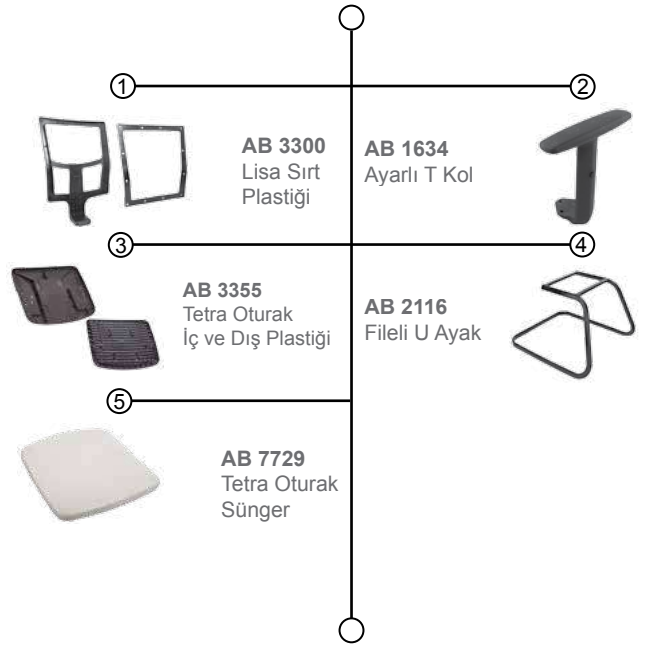

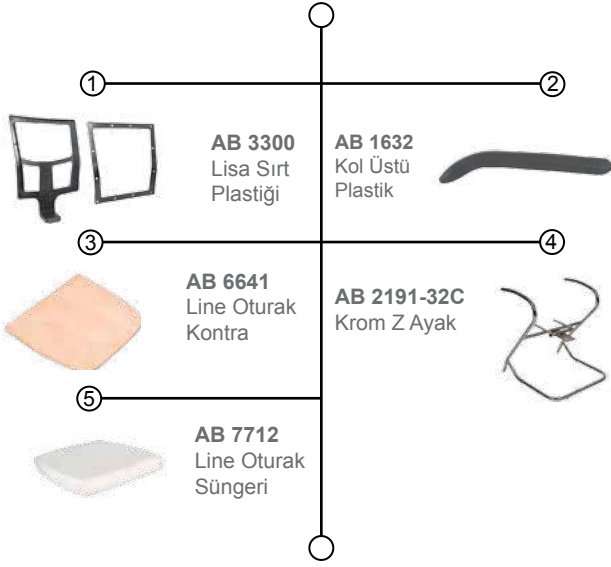

DOFİ / **AC8300** / COMPONENTS

DOFİ



DOFİ / **AC8310** / COMPONENTS



DOFİ / AC8311 / COMPONENTS



DOFİ / AC8330 / COMPONENTS

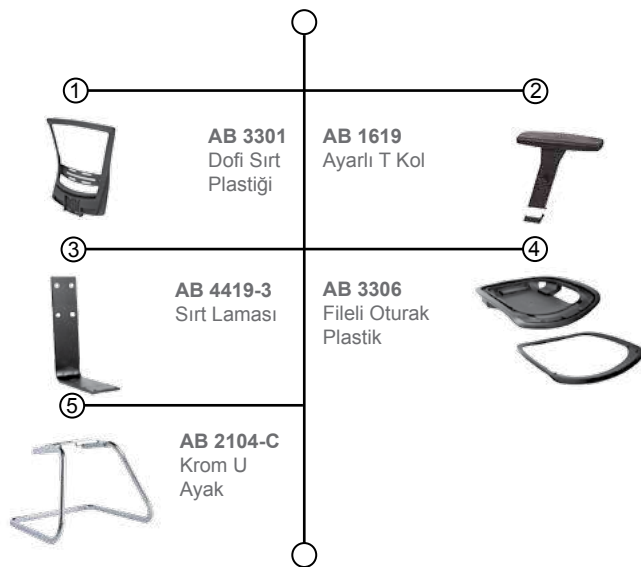

DOFİ / AC8306 / COMPONENTS

DOFİ



DOFİ / AC8316 / COMPONENTS



DOFİ / AC8317 / COMPONENTS



DOFİ / AC8336 / COMPONENTS

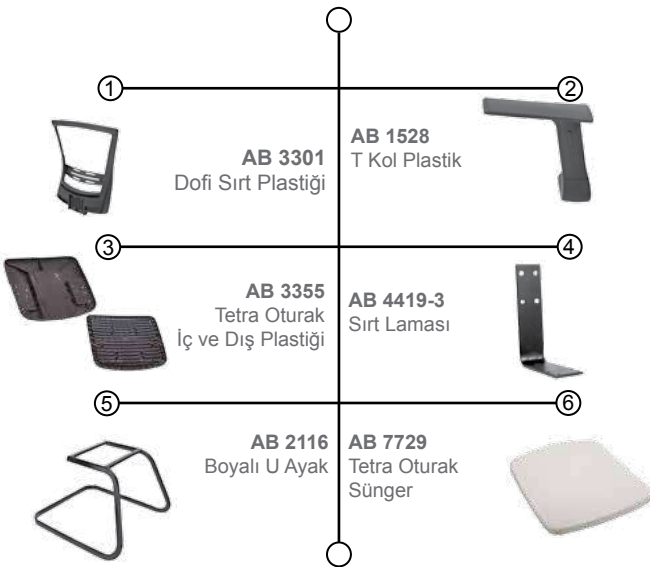

DONNA

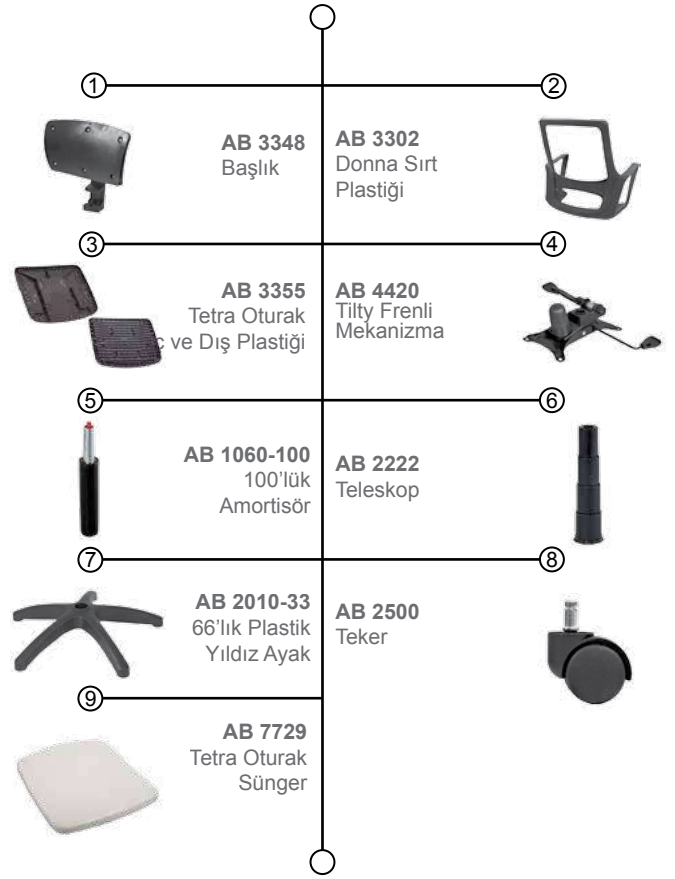

DONNA / AC8421 / COMPONENTS



DONNA / AC8431 / COMPONENTS





DONNA / AC8413 / COMPONENTS



DONNA / AC8432 / COMPONENTS



DONNA

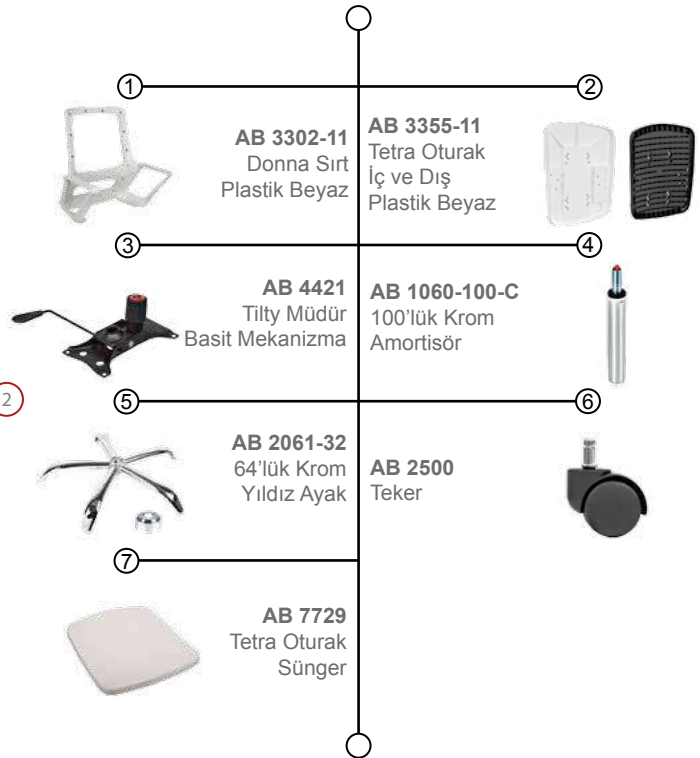

DONNA / AC8426 / COMPONENTS

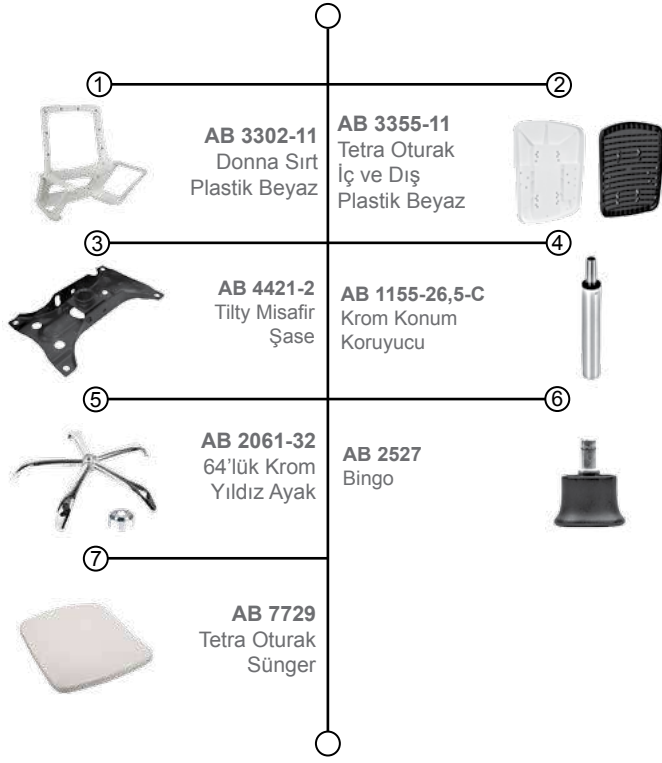

DONNA / AC8233 / COMPONENTS



LAKİ / AC8513 / COMPONENTS

YENİ RESİM GELECEK

LAKİ



LAKİ / AC8518 / COMPONENTS



LAKİ / AC8514 / COMPONENTS

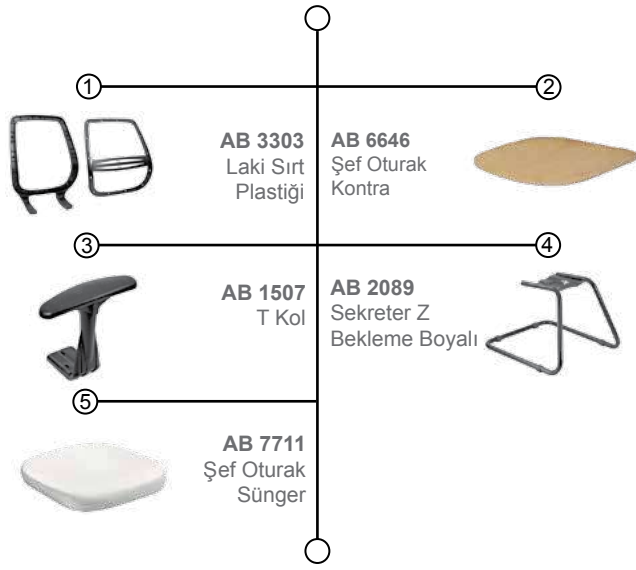

LAKİ / AC8520 / COMPONENTS

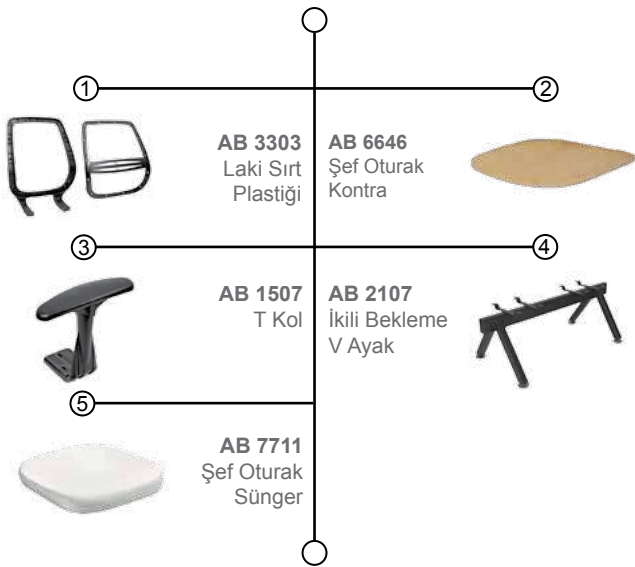

LANİ / AC8618 / COMPONENTS

RESİM KÖTÜ, TEKRAR ÇEKİLMESİ SAĞLIKLI OLUR.

LANİ

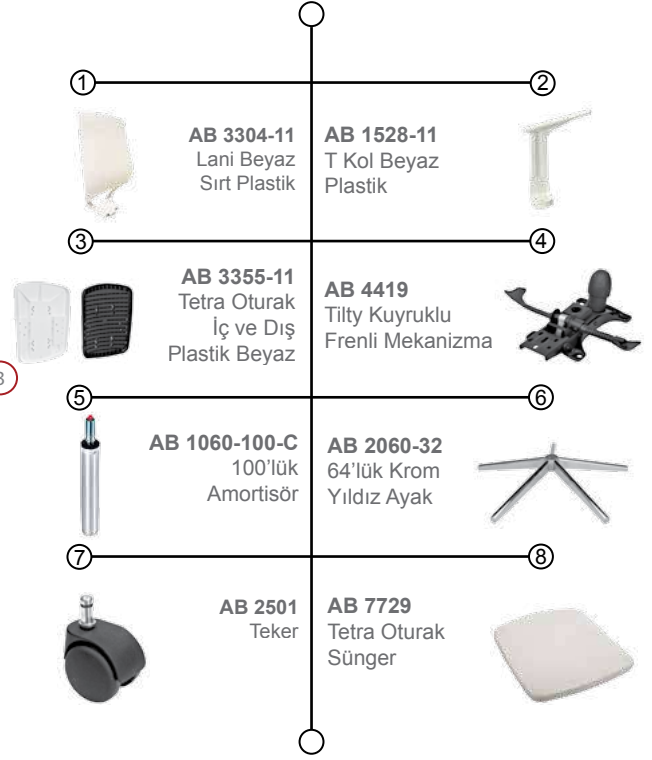

LANİ / AC8606 / COMPONENTS



LANİ / AC8636 / COMPONENTS

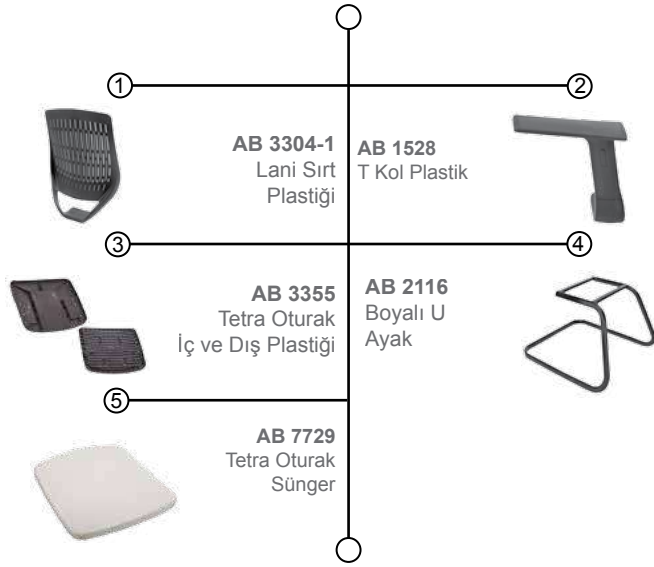

LANİ / AC8641 / COMPONENTS



WINNEY / AC8710 / COMPONENTS

WINNEY

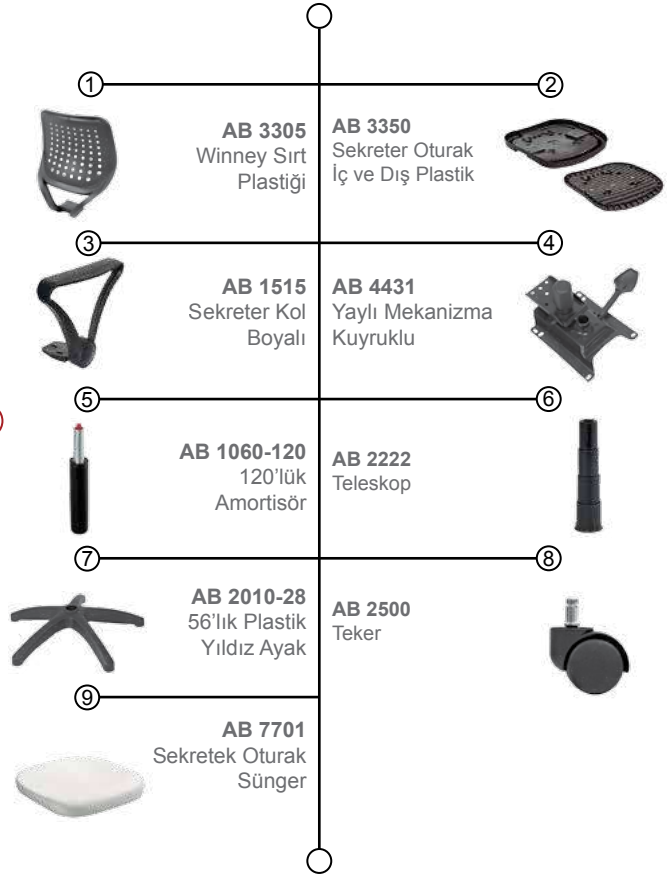

WINNEY / AC8732 / COMPONENTS

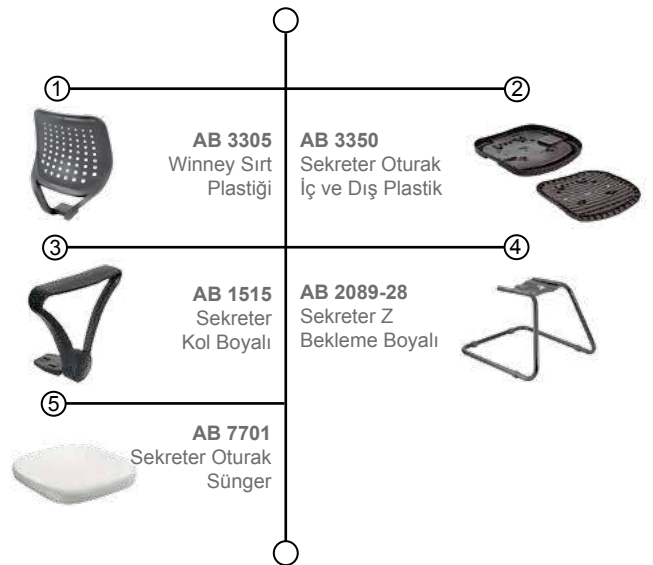

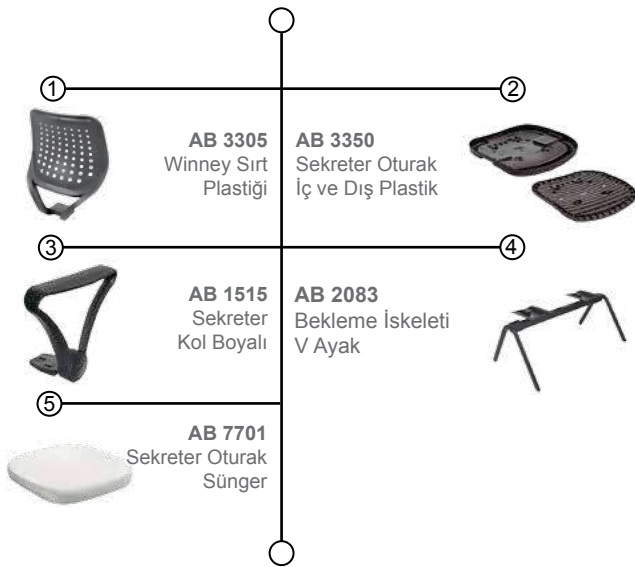

STEEL / AC8801 / COMPONENTS

STEEL

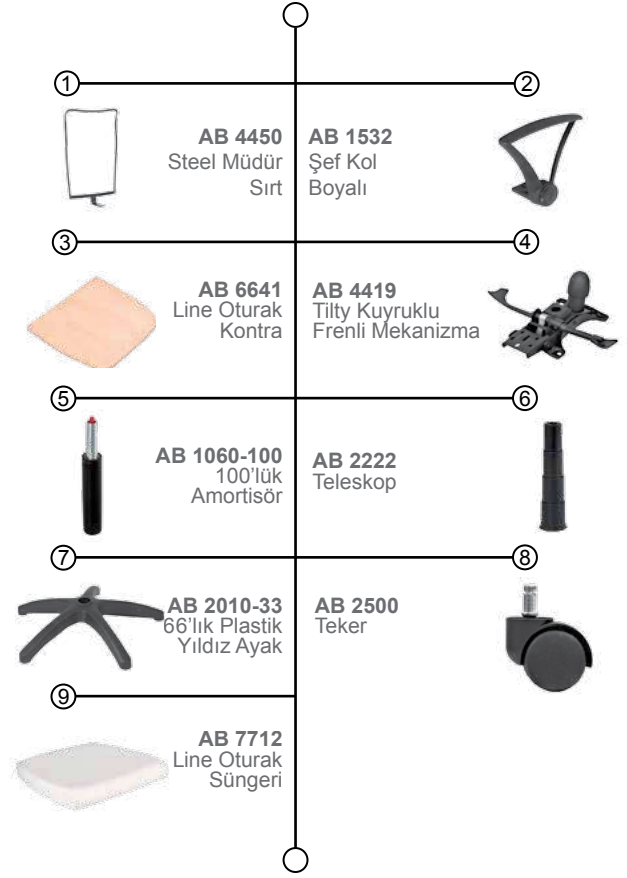

STEEL / AC8806 / COMPONENTS

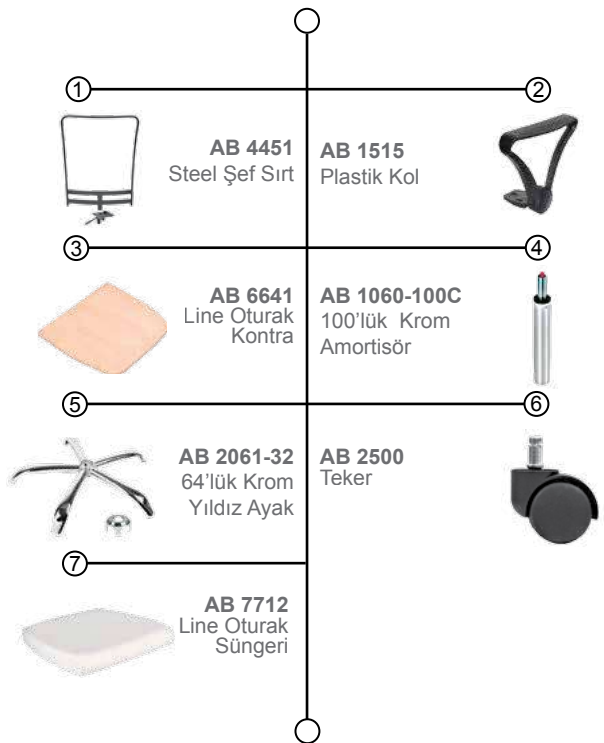

STEEL / **AC8807** / COMPONENTS



STEEL / **AC8841** / COMPONENTS



STEEL / **AC8850** / COMPONENTS

STEEL



STEEL / **AC8876** / COMPONENTS



STEEL / **AC8875** / COMPONENTS



SEM / AC4700 / COMPONENTS

SEM



SEM / AC4710 / COMPONENTS

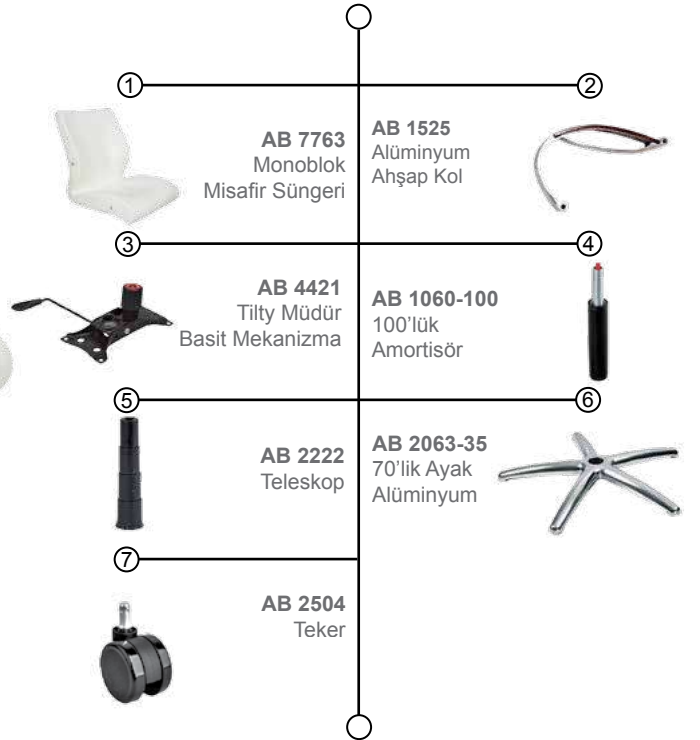

SEM / AC4720 / COMPONENTS



SEM / AC4750 / COMPONENTS



KRAL

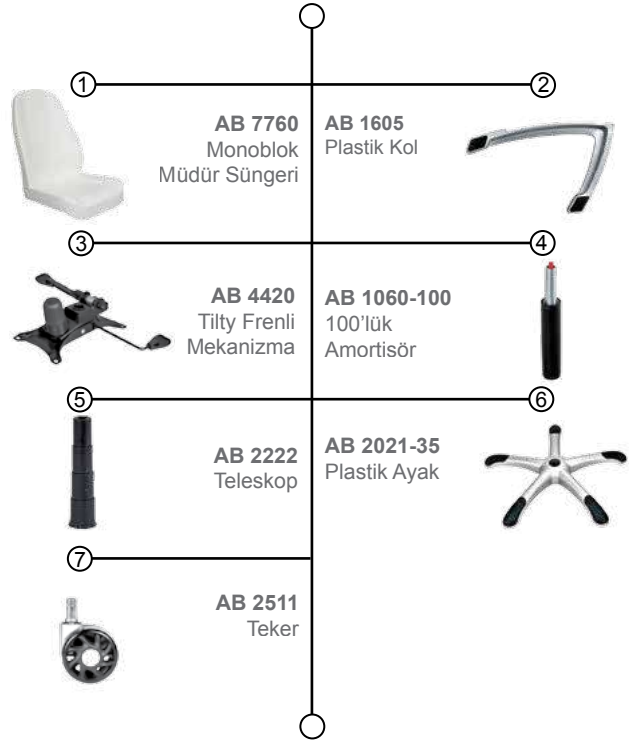

KRAL / AC4820 / COMPONENTS

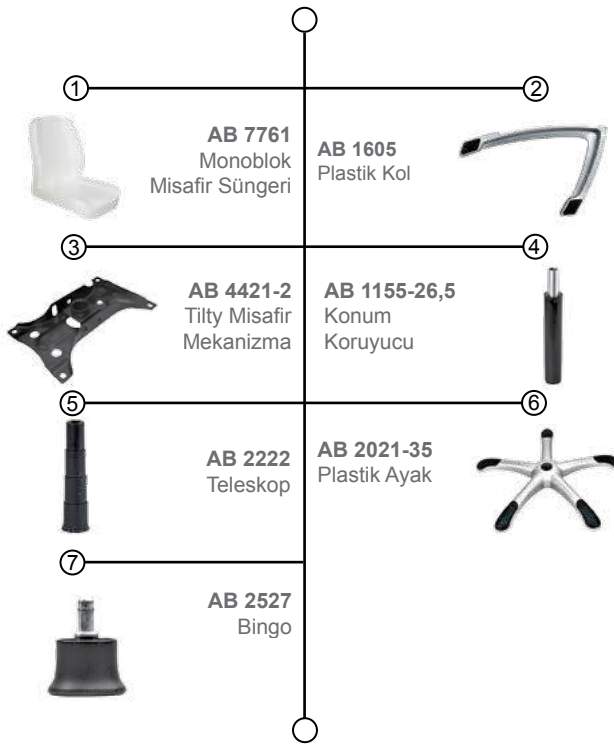

KRAL / AC4850 / COMPONENTS

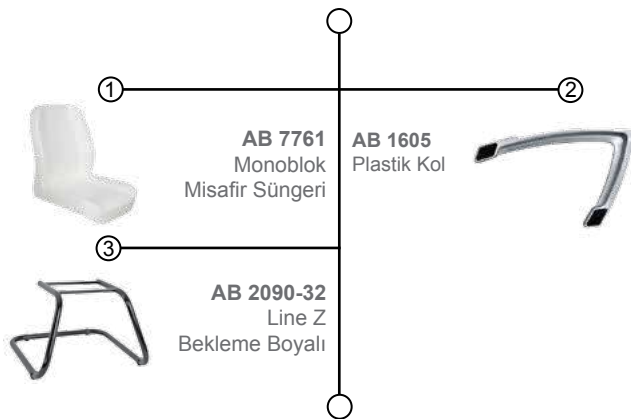

FRAG / AC7501 / COMPONENTS

FRAG

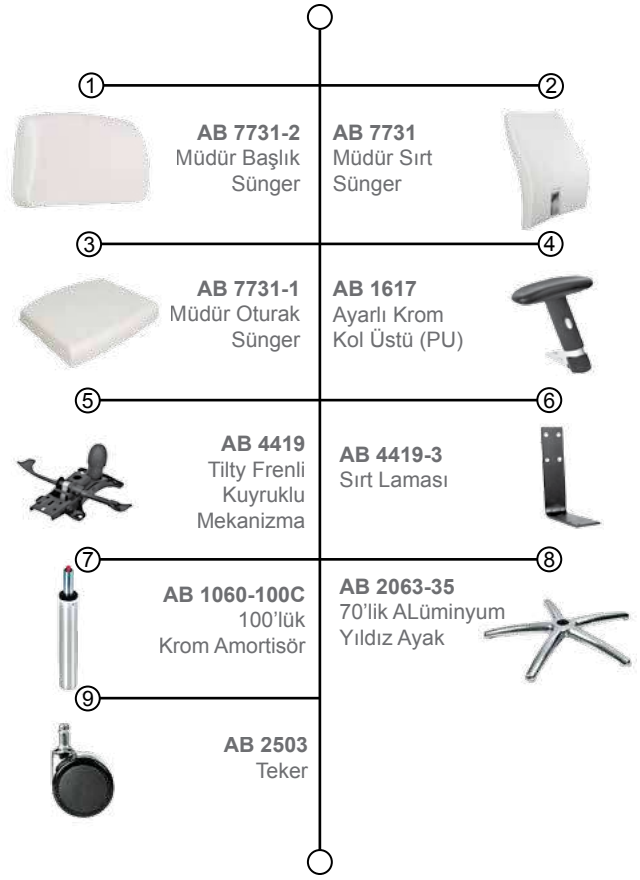

FRAG / AC7511 / COMPONENTS



FRAG / **AC7502** / COMPONENTS



FRAG / **AC7520** / COMPONENTS



ART / AC7000 / COMPONENTS

ART



ART / AC7010 / COMPONENTS

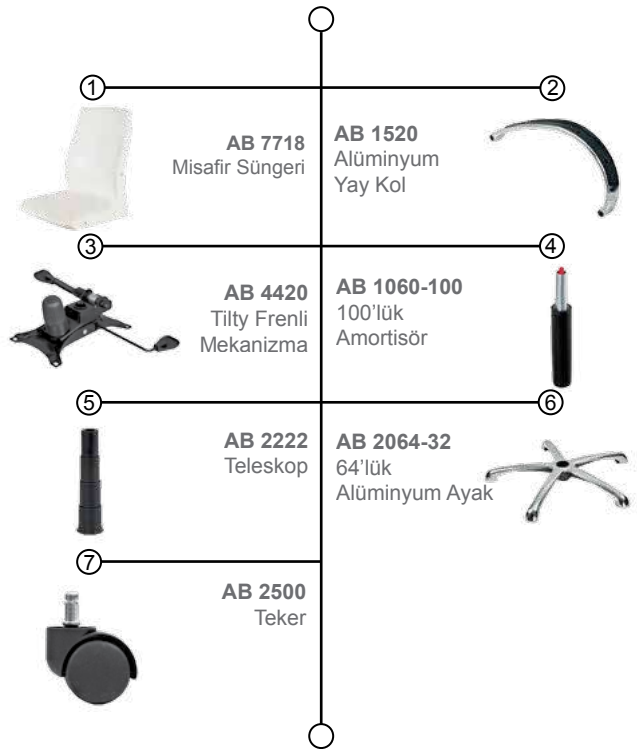

ART / **AC7030** / COMPONENTS

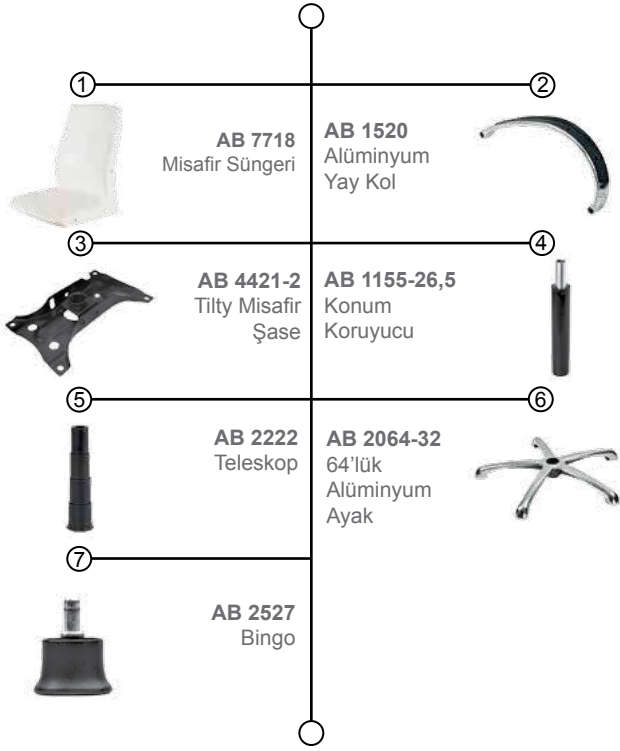

ART / **AC7020** / COMPONENTS

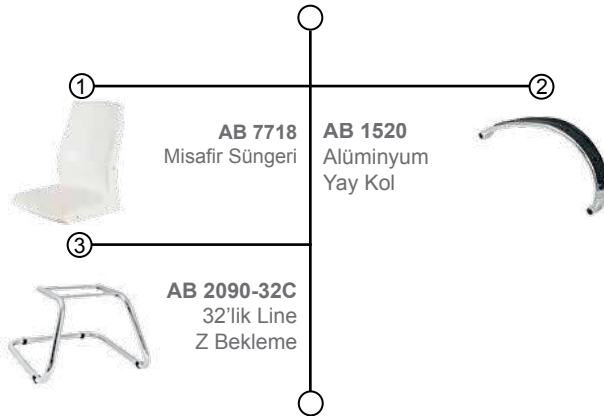

ART / AC7001 / COMPONENTS

ART



ART / AC7011 / COMPONENTS



ART / **AC7030** / COMPONENTS

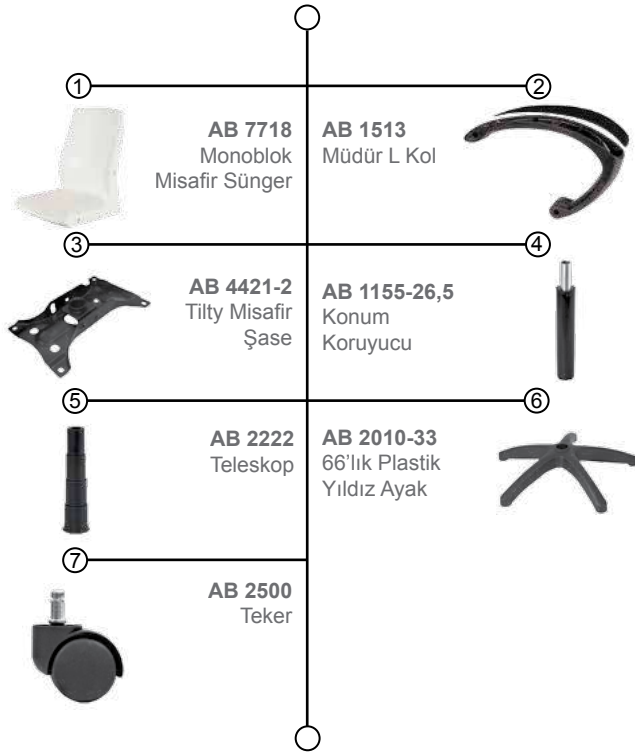

ART / **AC7021** / COMPONENTS

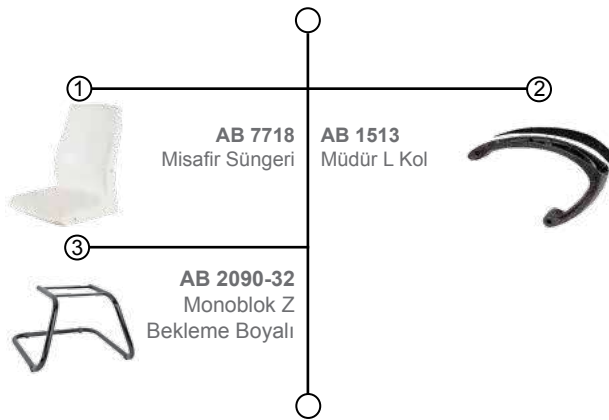

SİNA / AC5110 / COMPONENTS

SİNA

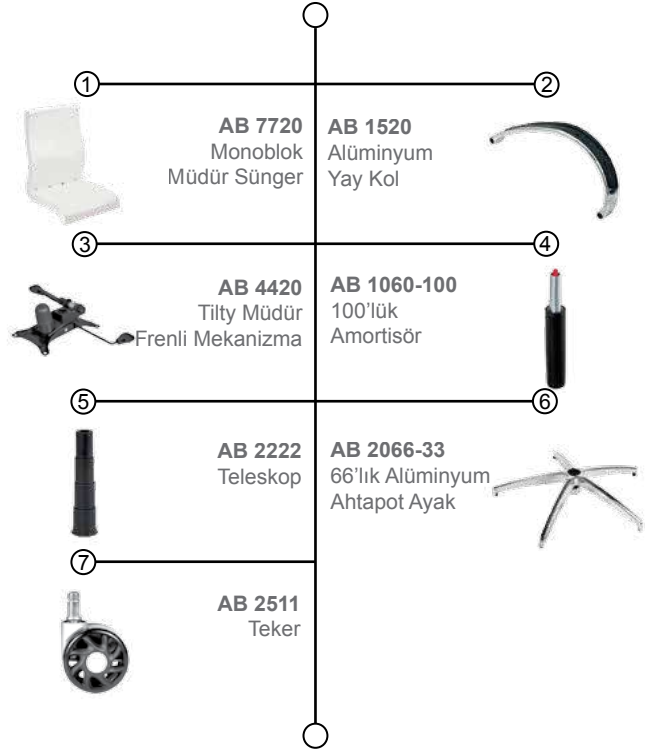

SİNA / AC5130 / COMPONENTS

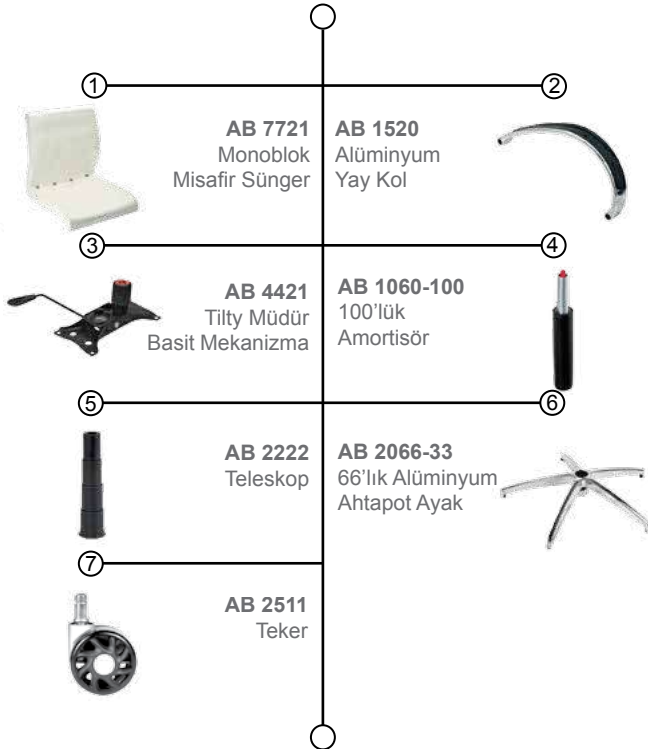

SİNA / AC5141 / COMPONENTS



SİNA / AC5150 / COMPONENTS



SİNA / AC5112 / COMPONENTS

SİNA

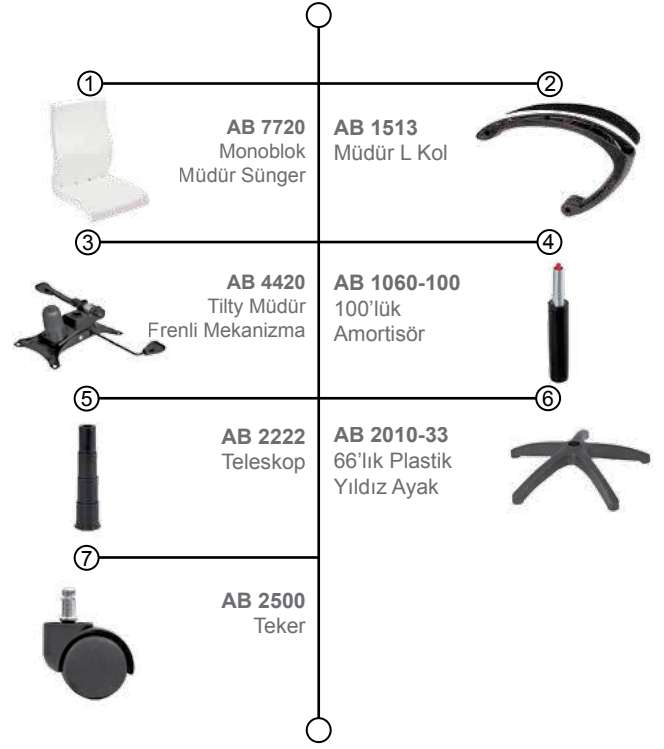

SİNA / AC5132 / COMPONENTS

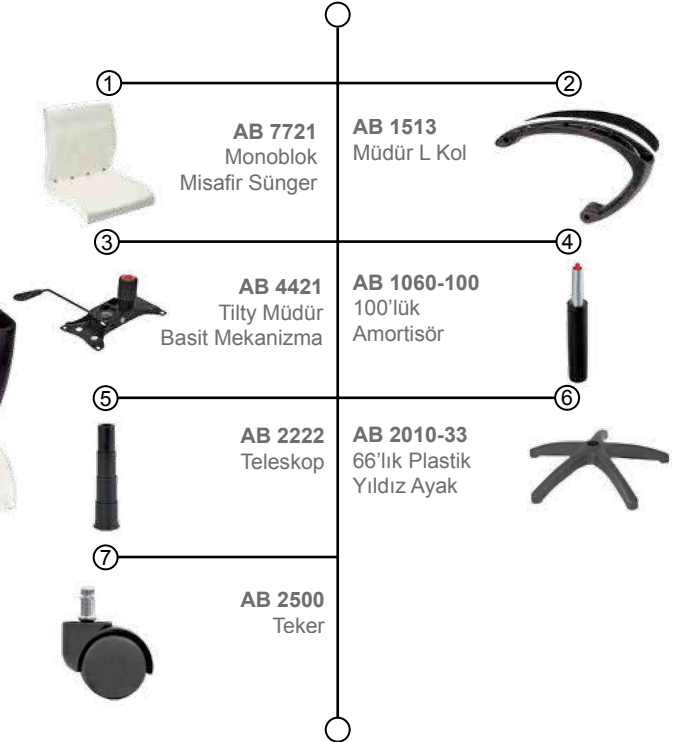

SİNA / AC5142 / COMPONENTS



SİNA / AC5152 / COMPONENTS



SINA / **AC5170** / COMPONENTS

SINA

SINA / **AC5172** / COMPONENTS



SINA / **AC5178** / COMPONENTS



SINA / **AC5179** / COMPONENTS



SINA / **AC5180** / COMPONENTS

SINA



SINA / **AC5185** / COMPONENTS





SİNA

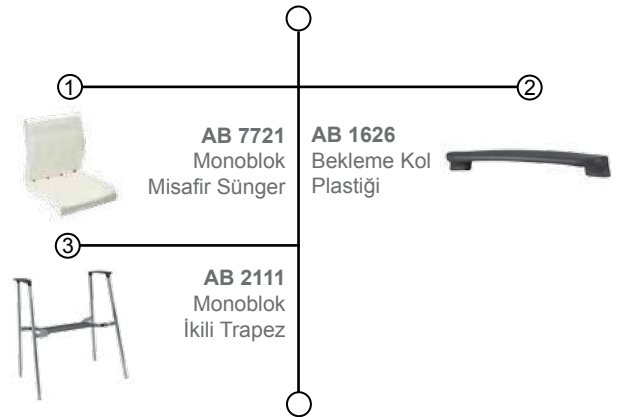
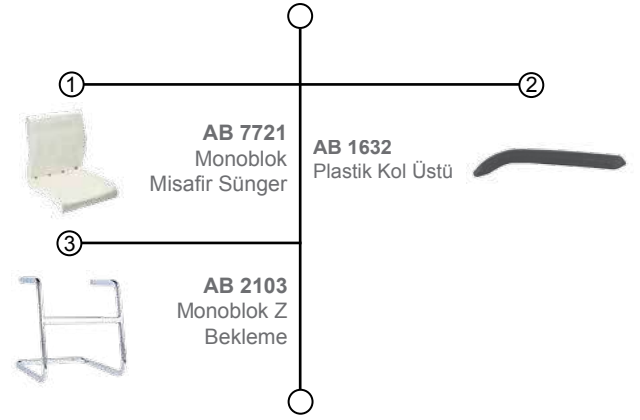

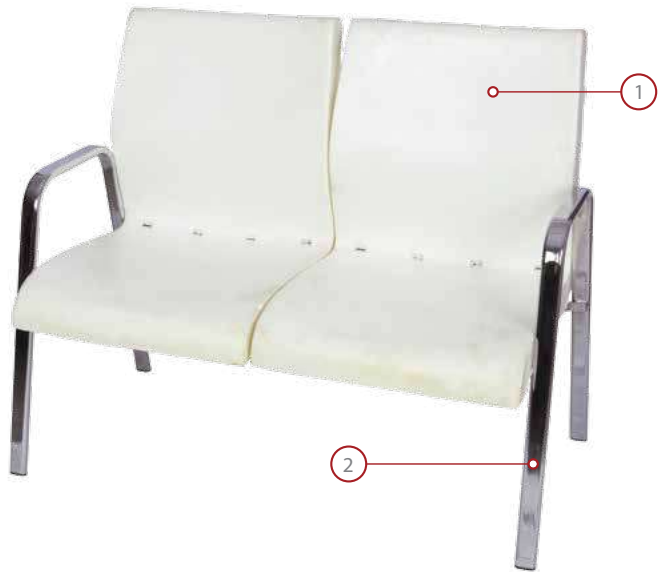
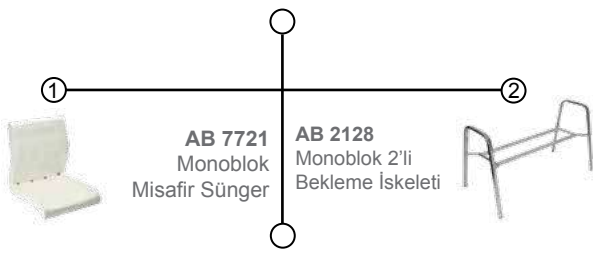
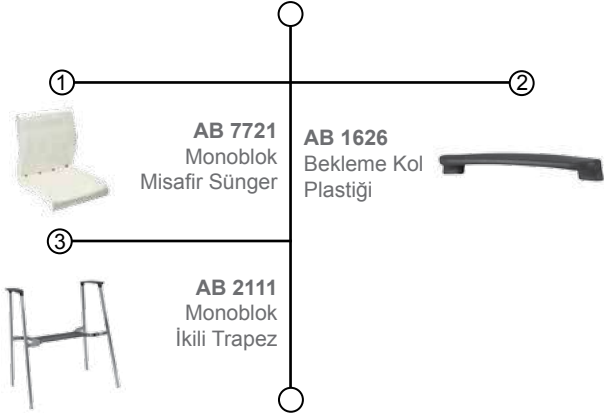

DEGREE / AC4900 / COMPONENTS

DEGREE



DEGREE / AC4910 / COMPONENTS



DEGREE / **AC4940** / COMPONENTS



DEGREE / **AC4920** / COMPONENTS

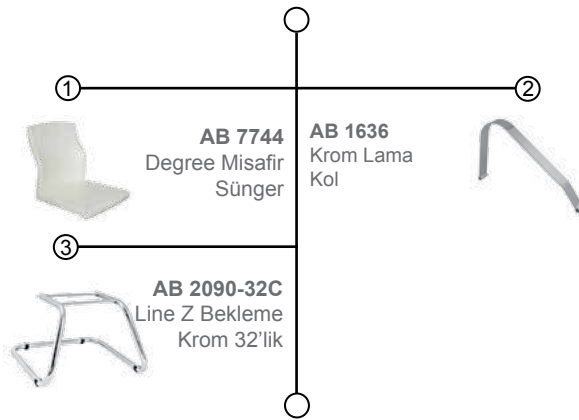

DEGREE



SERK



SERK / **AC7086** / COMPONENTS

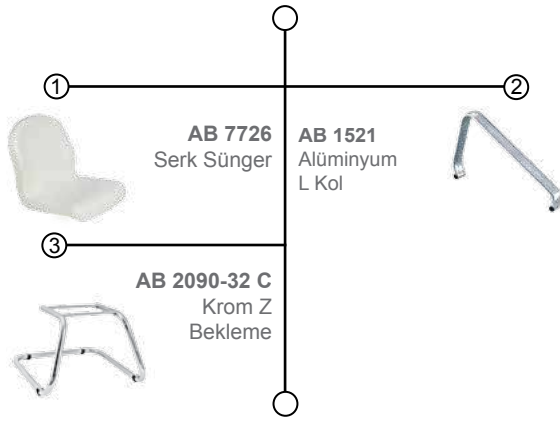

SERK / **AC7084** / COMPONENTS

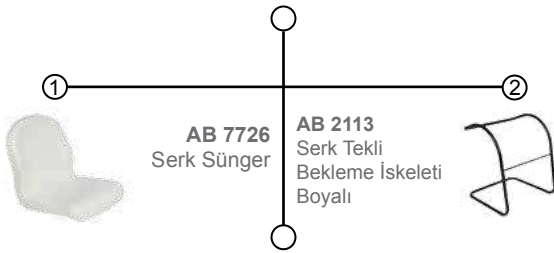

PETTA / AC5173 / COMPONENTS

PETTA

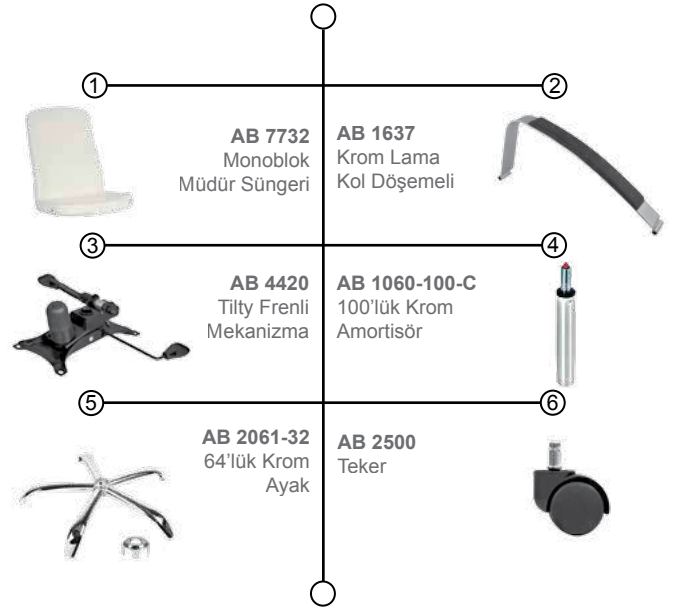

PETTA / AC5174 / COMPONENTS

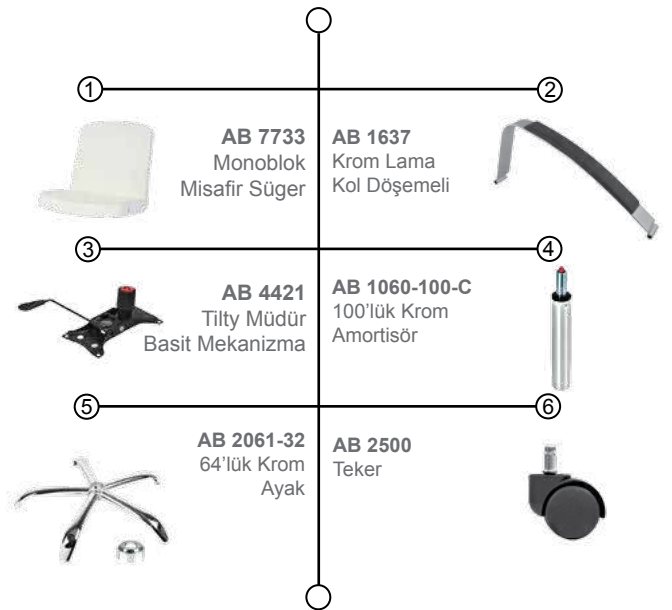

PETTA / AC5175 / COMPONENTS



PETTA / AC5176 / COMPONENTS

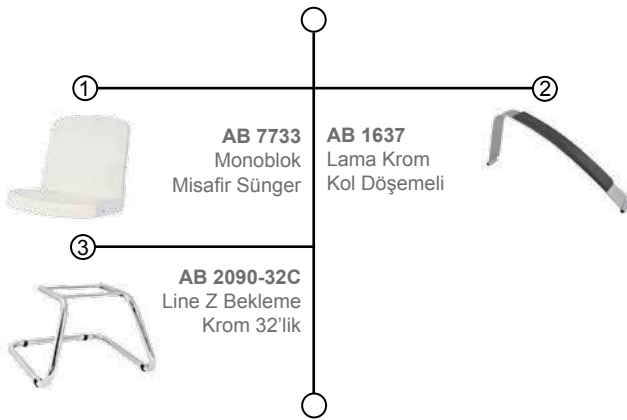

PETTA / AC5161 / COMPONENTS

PETTA

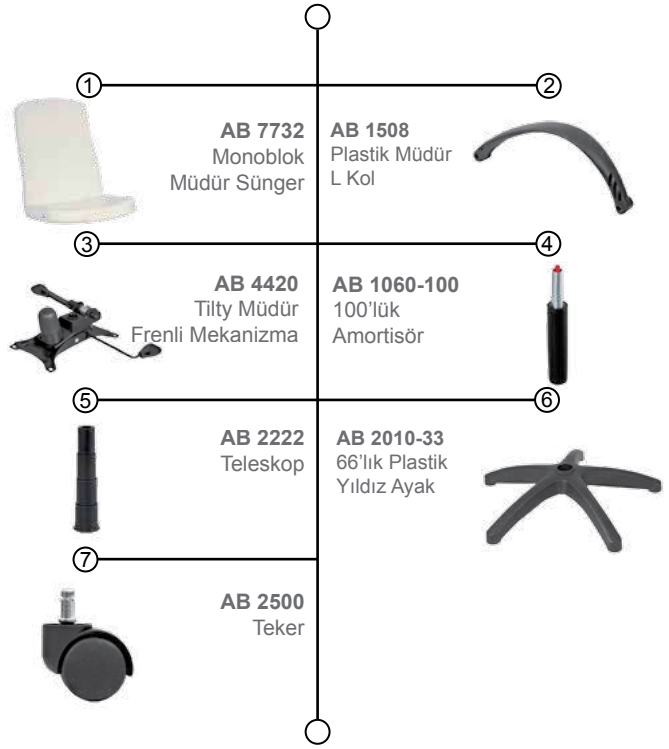

PETTA / AC5162 / COMPONENTS

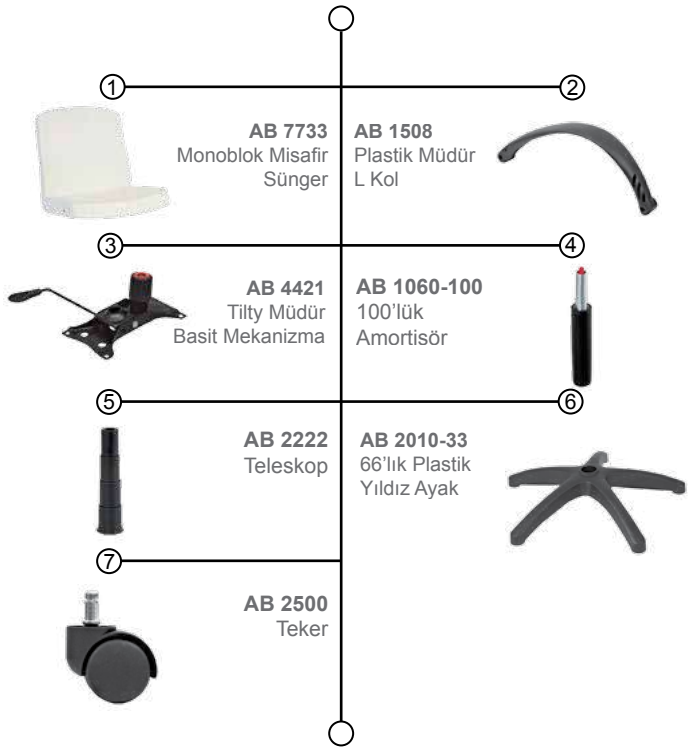

PETTA / AC5164 / COMPONENTS

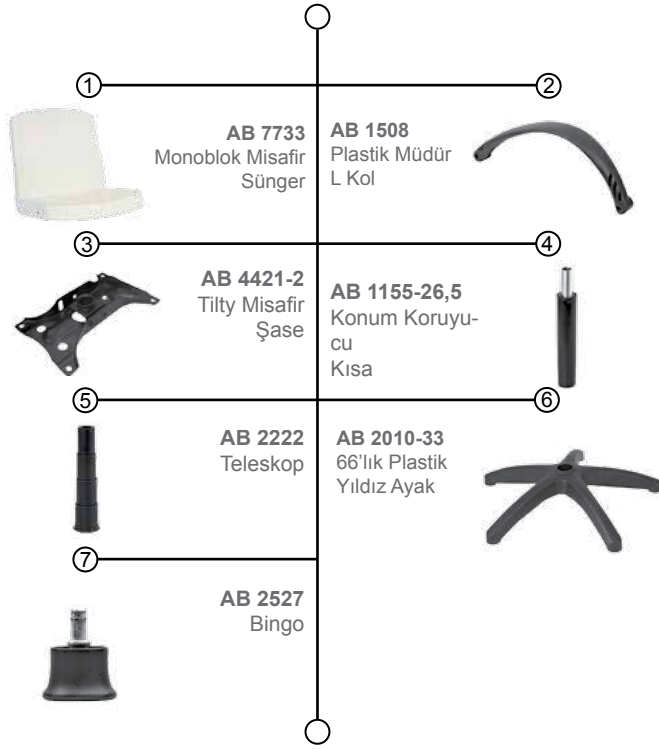

PETTA / AC5163 / COMPONENTS

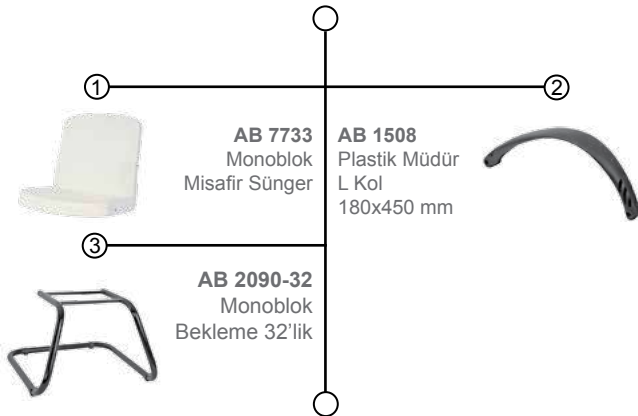

CHANTRA

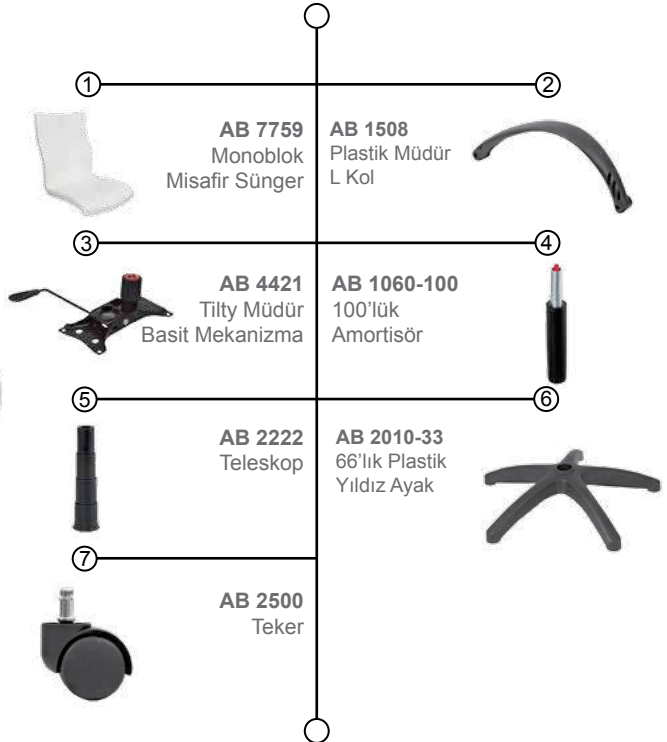
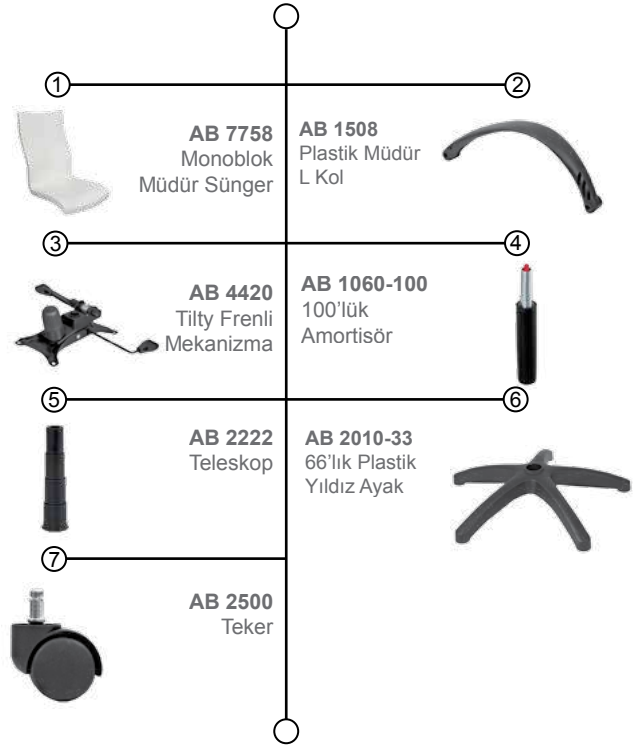

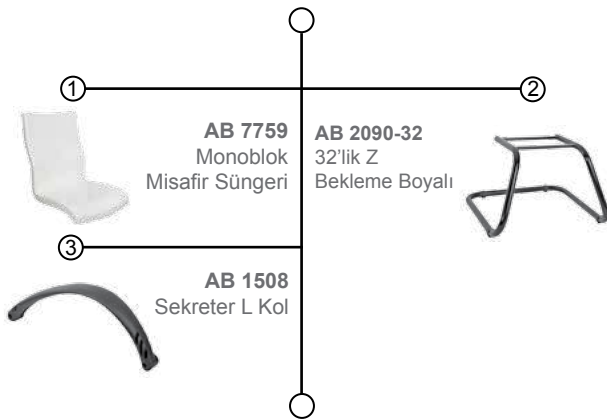

LİDO / AC7080 / COMPONENTS

LİDO

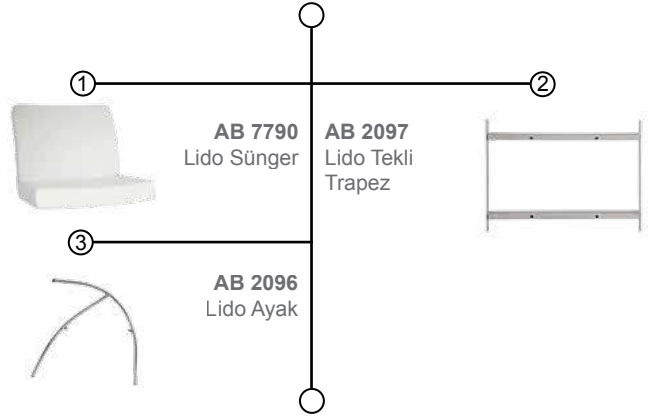

LİDO / AC7081 / COMPONENTS

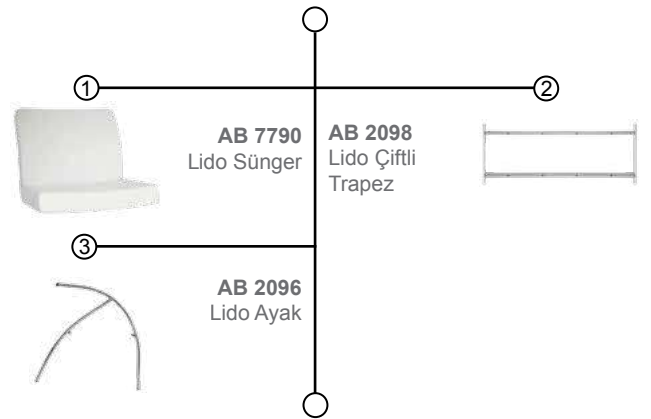

LİDO / AC7082 / COMPONENTS

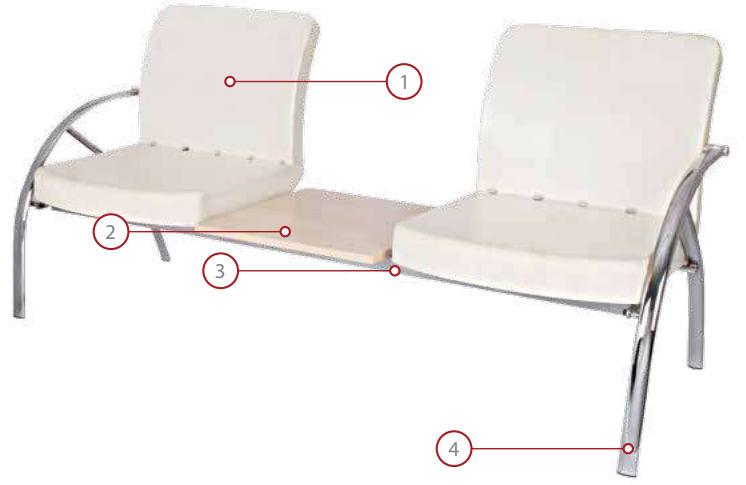
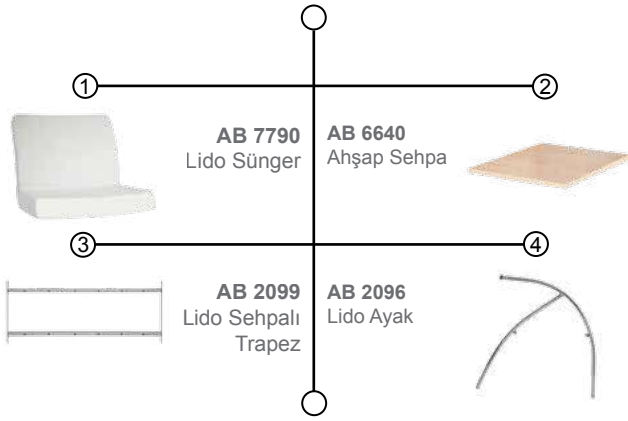

LİDO / AC7083 / COMPONENTS

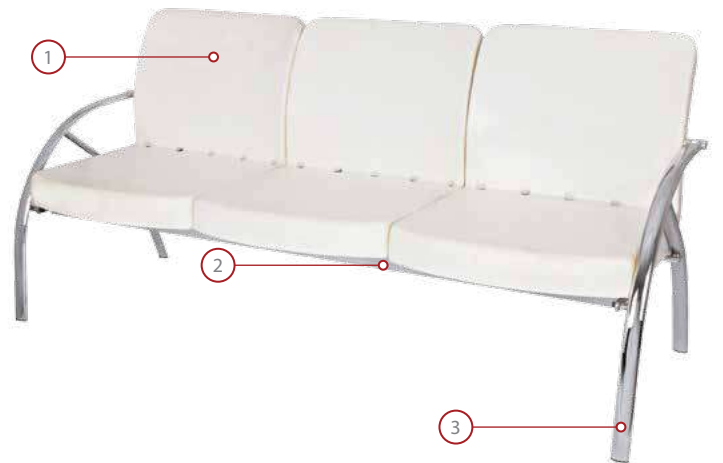
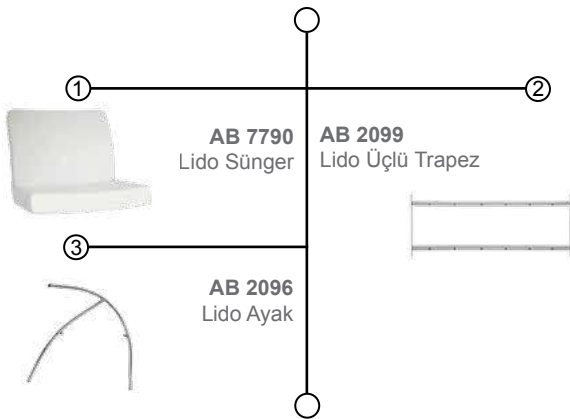

COMODO / AC9673 / COMPONENTS

COMODO

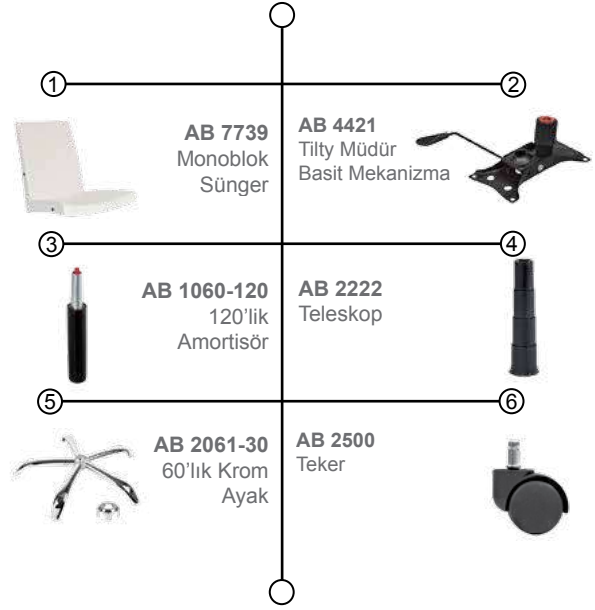

COMODO / AC6970 / COMPONENTS

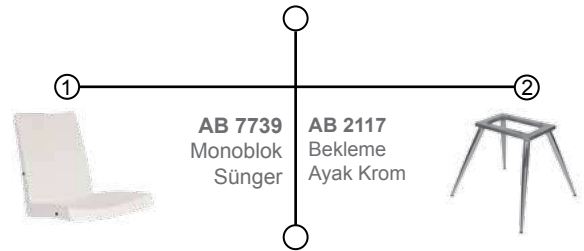



CARE

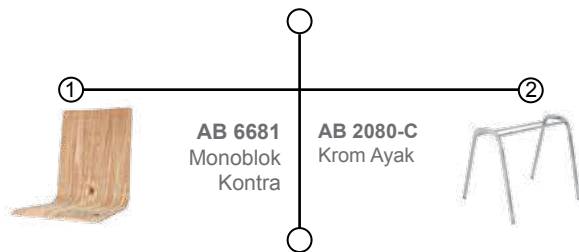

TARE / AC7060 / COMPONENTS

TARE



VİVA

VİVA / AC5669 / COMPONENTS

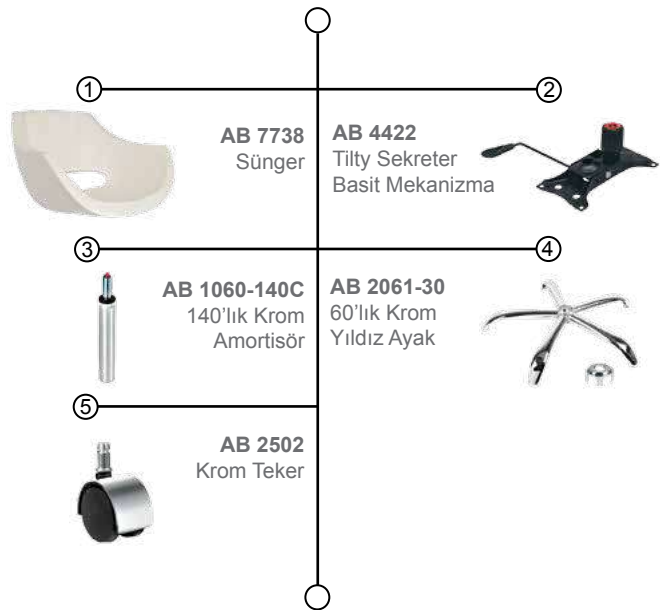

HARMONY

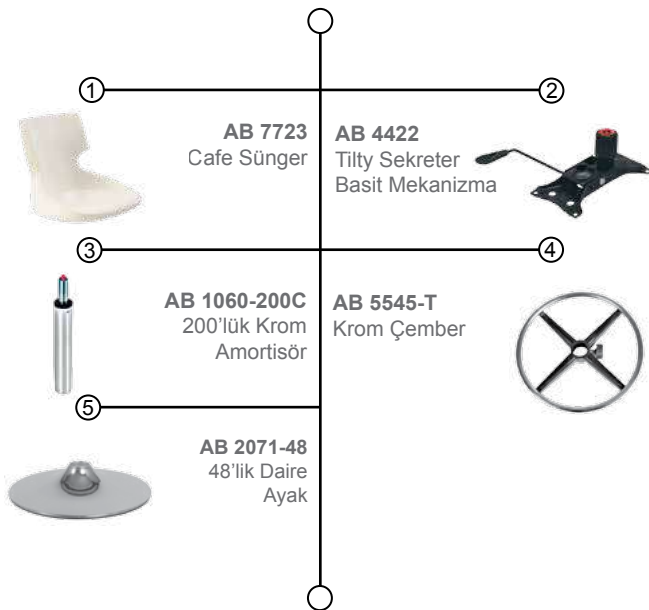
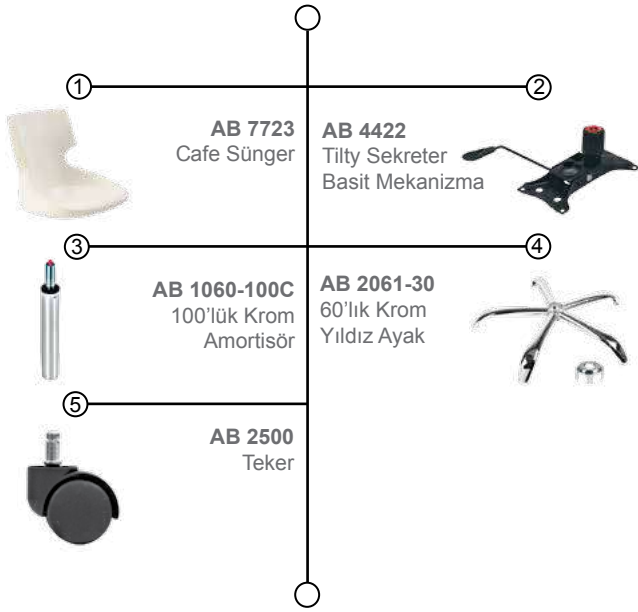

HARMONY

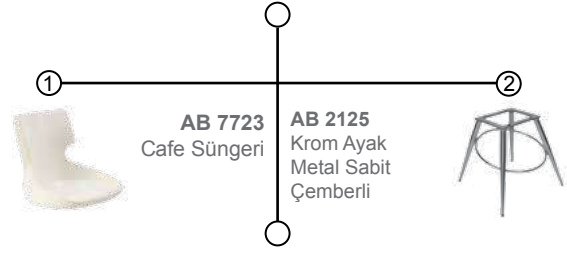

YAPRAK



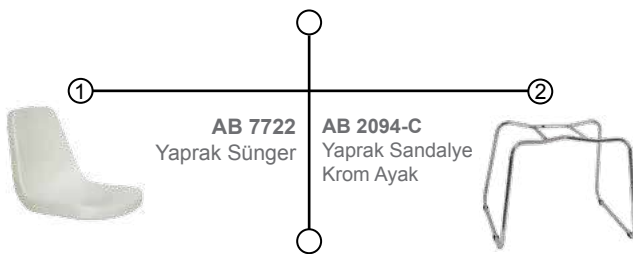
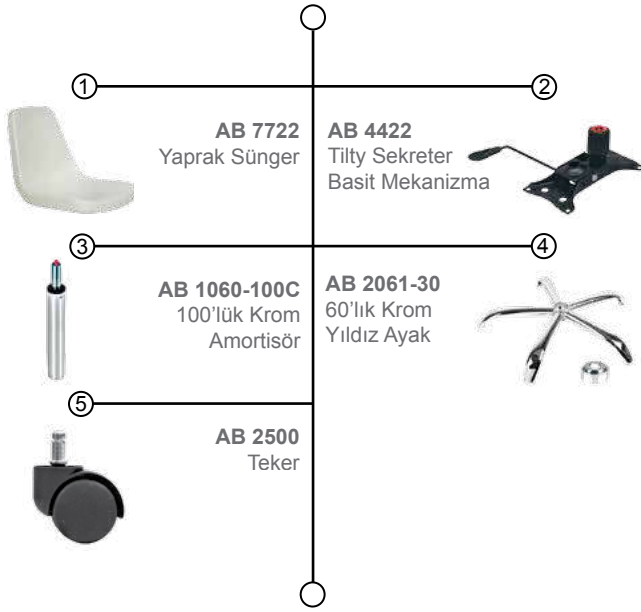

YAPRAK

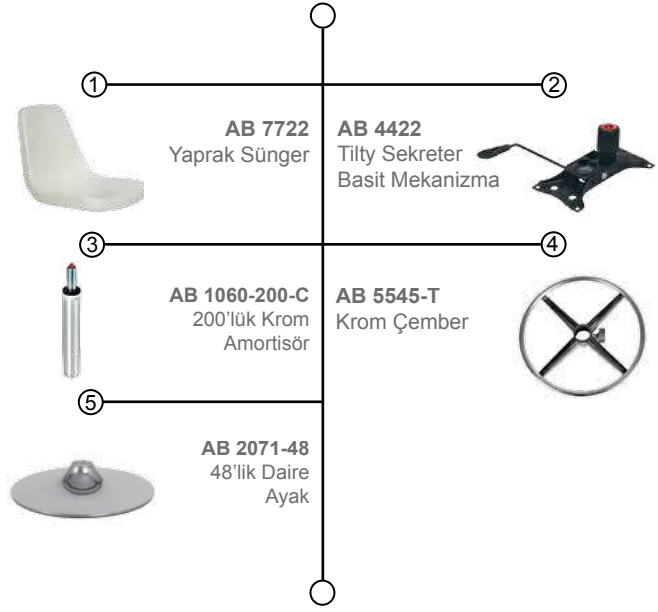

CAFE

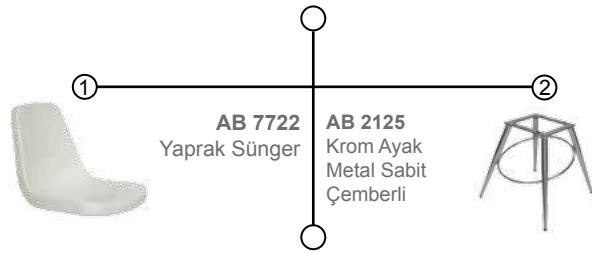

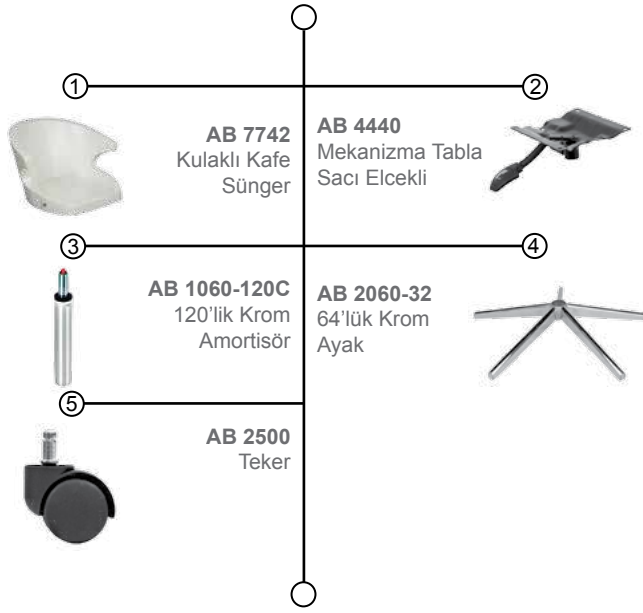

ZARE



ZARE / AC7050 / COMPONENTS

ZARE

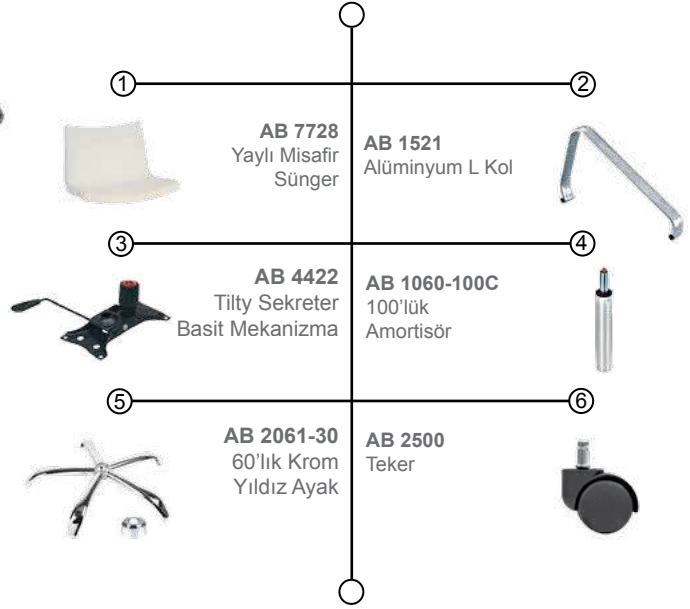

ZARE / AC7042 / COMPONENTS

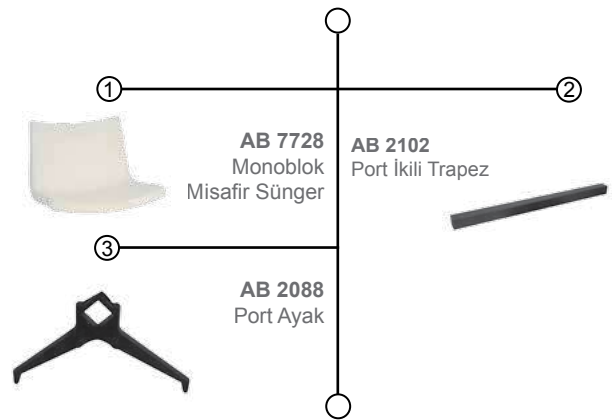

SERK / **AC7055** / COMPONENTS



SERK / **AC7095** / COMPONENTS



ZARE / **AC7052** / COMPONENTS



ZARE / **AC7051** / COMPONENTS



SERK / **AC6520** / COMPONENTS



SERK / **AC6610** / COMPONENTS



SMOOTH / AC7070 / COMPONENTS

SMOOTH

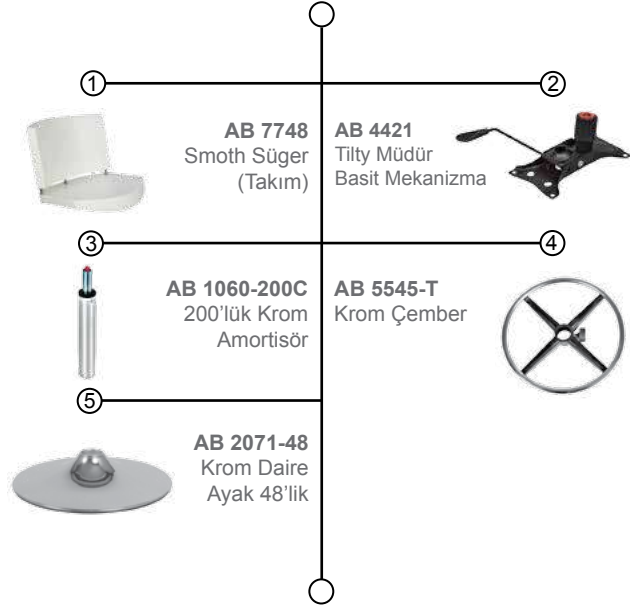

SMOOTH / AC7072 / COMPONENTS

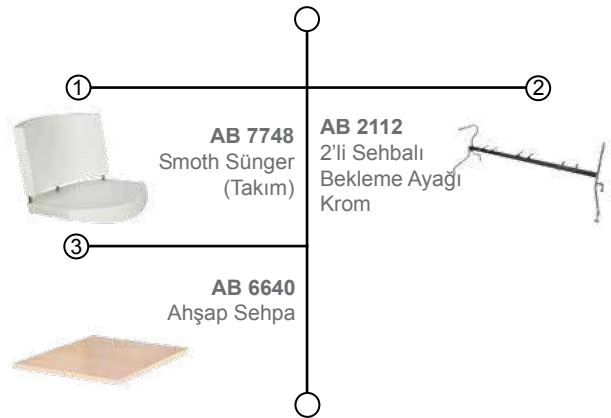

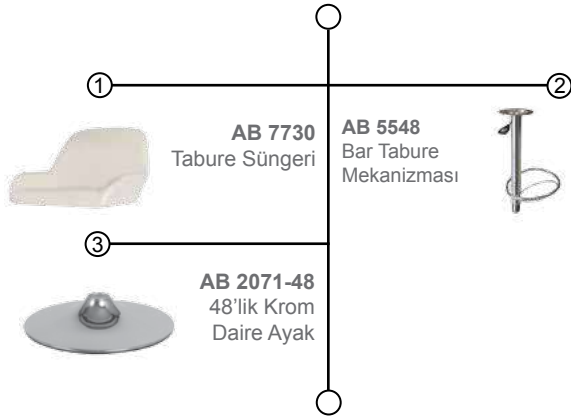

BAR

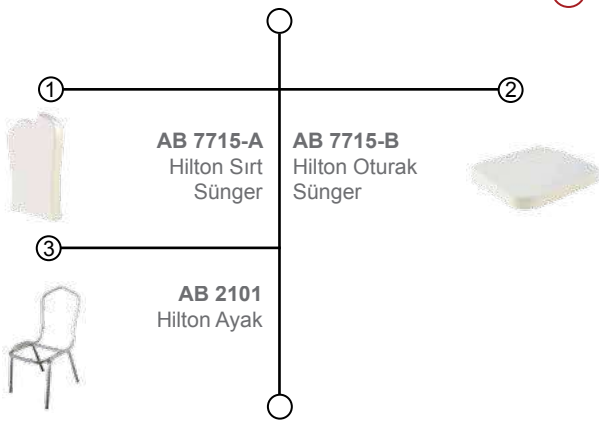

HİLTON

SARA

